

JBC

www.jbctools.com

English



Compact Desoldering Station with Pneumatic Pump

Ref. CV-D

Packing List

The following items should be included:

CSV Control Unit

Ref. CSV-1D (120V)
CSV-2D (230V)
CSV-9D (100V)



Micro Desoldering Iron

Ref. DS360-A



Power Cord

Ref. 0009417 (100V/120V)
0009401 (230V)



Brass Wool

Ref. CL6210

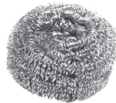

Sponge

Ref. S0354



DS360-A Accessories Ref. 0010259



Tips (5 units) Ref. C360002	Tips (5 units) Ref. C360004	Cleaning Rods Ref. 0008466
		
Filter (2 units) Ref. 0008473	Cleaning brush Ref. 0008297	Solder Collector (2 units) Ref. 0008467
		

Pneumatic Desoldering Module Ref. MV-A



50 Filter Box Ref. 0005966



Cotton Filters Ref. 0781046



Escape Filter Ref. 0008446



Suction Filter Ref. 0821830



Module Cable connector Ref. 0010207



Manual



Features

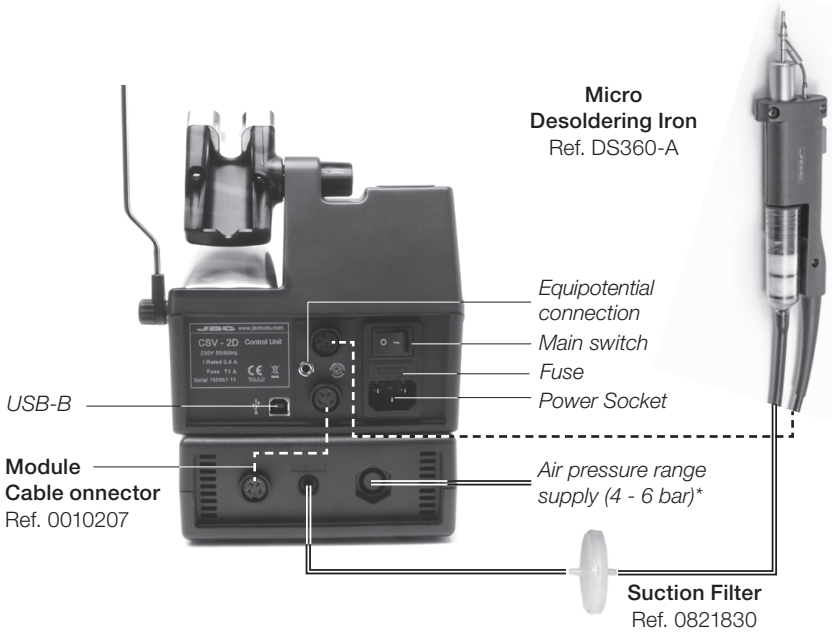
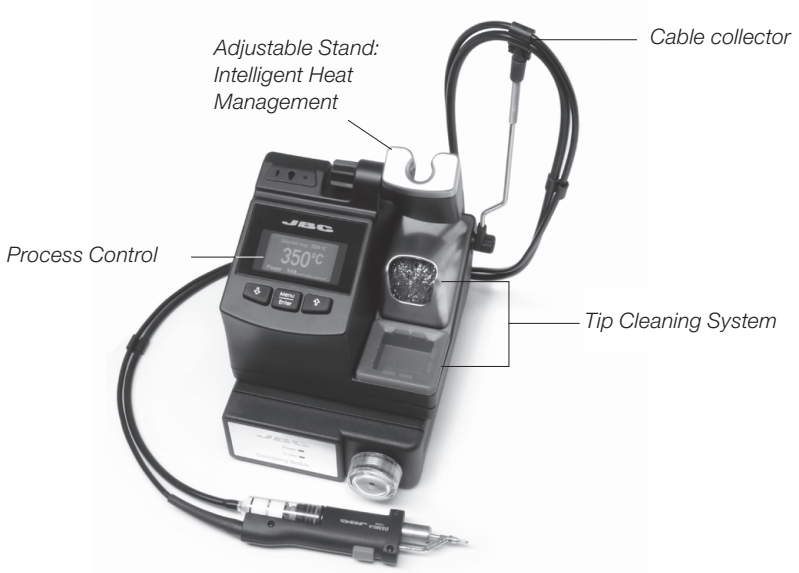

*It is required available compressed air at the operator's bench.

Adjustable Stand

Tilt the tool stand to suit your work position.



Cable collector

Place the cable on the collector and adjust to keep work area free of cable.

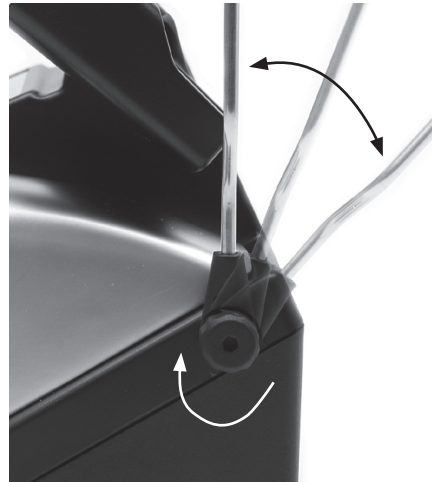
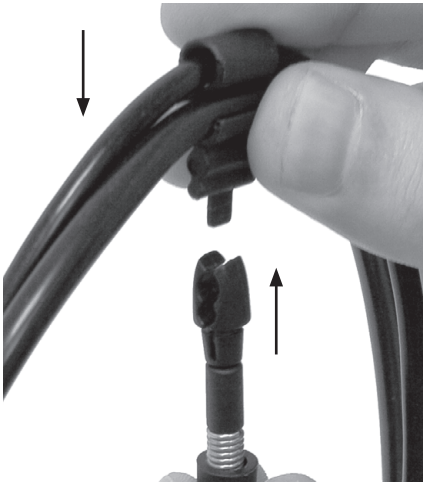

Tip Cleaning System

Select the option that best suits your tip cleaning needs.

Splashguard

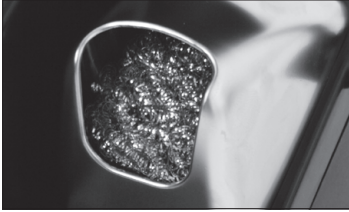

Brass Wool

Ref. CL6210

Very effective cleaning method. Leaves a small layer of solder on the tip preventing oxidation between cleaning and reflowing.

More options for the splashguard (not supplied):

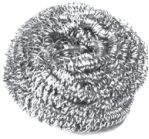

Inox Wool

Ref. CL6205

Provides a superior cleaning on the tip.

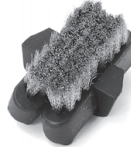

Metal Brush

Ref. CL6220

When used carefully, it provides a more thorough cleaning.

Tip Wipe

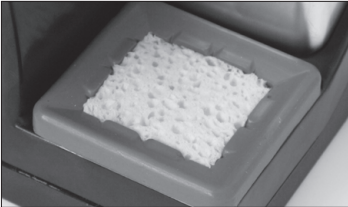

Sponge

Ref. S0354

The least harmful cleaning method. Keep the sponge damp with distilled water when working to avoid tip wear.

Tapping:

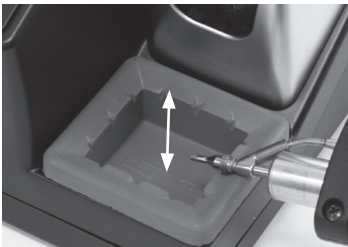

Tap gently to remove the excess solder.

Wiping:

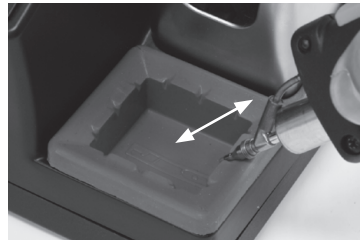

Use the slots to wipe off any remaining particles.

USB Connector

Download the latest softwares from our website to improve your soldering station.

JBC Updater

www.jbctools.com/software.html

Update the station software via USB connection:



JBC Manager

www.jbctools.com/manager.html

Manage and monitor as many stations as your Windows PC can handle by using the JBC Manager software. You can export data to other PCs.

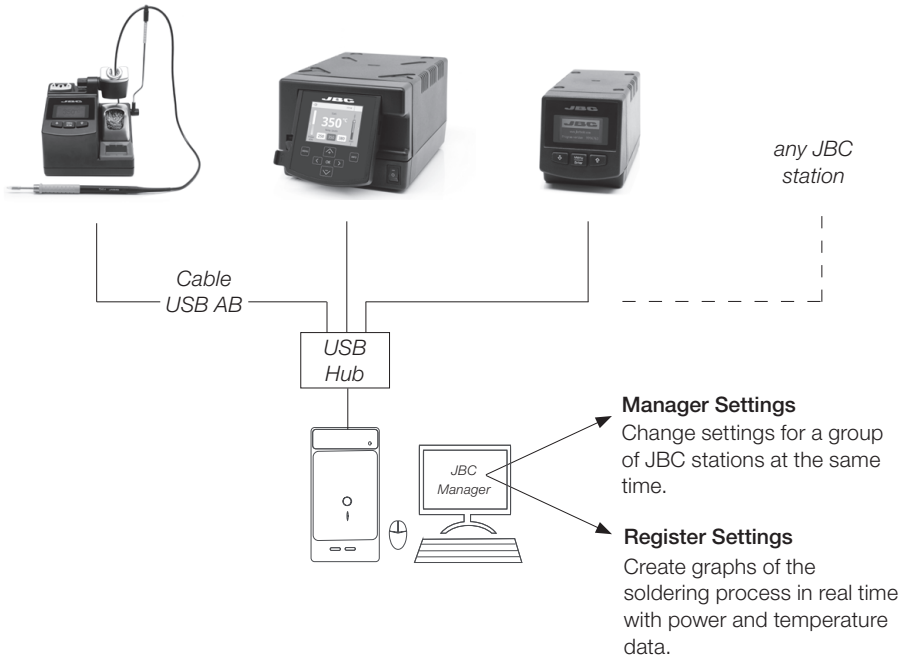

Operation

The JBC Exclusive Heating System

This revolutionary technology is able to recover tip temperature extremely quickly.

This allows the user to work at a lower temperature.

As a result, tip life increases x5 times.

1. Work



Lift tool from the stand and the tool tip will heat up to the selected temperature.

2. Sleep



When the tool is in the stand, the temperature reduces to Sleep temperature (pre-set 260°C / 500°F).

3. Hibernation



After long periods in the stand (pre-set 30 min), the power is cut and the tool cools down to room temperature.

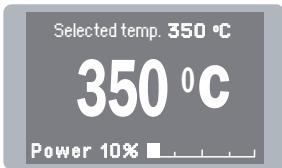

Change temperature
(from 180 to 450°C)

- Tool Settings:
- Select temperature levels
 - Fix one temperature



- Tool Settings:
- Set Sleep temperature
 - Set Sleep delay
(from 0 to 9 min or no Sleep)



- Tool Settings:
- Set Hibernation delay
(from 0 to 35 min or no hibernation)

Process Control

Work Screen

This screen provides useful information of tool status in real time.

Fixed temp. **350 °C** — Displays a specific fixed temp.

Levels °C **270 350 400** — Shown when you have selected temp. levels.

Selected temp. **350 °C**

350 °C

Power 10%

↓ Menu Enter ↑

Menu Screen

Original PIN: 0105

Main menu

- Exit
- 1 Reset settings
- 2 Station settings
- 3 Tool settings
- 4 Counters
- 5 Program version

Station settings

- 1 Temp unit Celsius
- 2 Maximum temp 400°C
- 3 Minimum temp 200°C
- 4 Help text OFF
- 5 Beep ON
- 6 Change PIN
- Back

Tool settings

- 1 Fix one temp ----
- 2 Temp levels set OFF
- 3 Sleep delay 0 min
- Tool DS
- 4 Sleep temp 260°C
- 5 Hibernation delay 30 min
- 6 Temp adjust +0 °C
- Back Tool DS

Counters

- 1 Plugged hours 0
- 2 Working hours 0
- 3 Sleep hours 0
- 4 Hibernation hours 0
- 5 No tool hours 0
- 6 Sleep cycles 0
- 7 Desold cycles 0
- Back

Changing the Tip

1. Remove the tip by using a flat-nosed pliers. Twist the tip and pull.
2. Insert the new tip and follow the same steps conversely.

Important:

Change tips only when the tool is hot.

Do not hold the tip on the spring clamp.

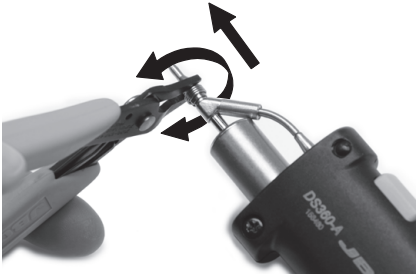

Compatible tips

The CS and CV desoldering stations work with C360 tip range. Find the model that best suits your desoldering needs on www.jbctools.com

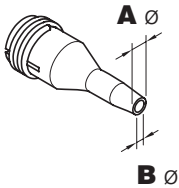

C360-001



ØA: 1
ØB: 0.8
Ømax.pin: 0.4

C360-002



ØA: 1.2
ØB: 0.8
Ømax.pin: 0.6

C360-003



ØA: 1.4
ØB: 1
Ømax.pin: 0.8

C360-004

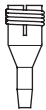

ØA: 1.4
ØB: 1
Ømax.pin: 0.8

C360-007



ØA: 1.9
ØB: 1.4
Ømax.pin: 1.2

C360-006

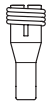

ØA: 3
ØB: 1.5
Ømax.pin: 1.3

Tip selection

Remember to select the biggest tip possible for your application: $\text{Ø Inner nozzle} > \text{Ø Pin}$.

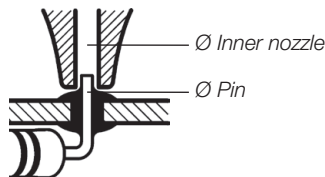

Changing the Heating Element

1. Pull off the filter and the solder collector.
2. Undo the fixing screw indicated in the picture and remove the heating element.
3. Insert the new heating element following the same steps conversely.

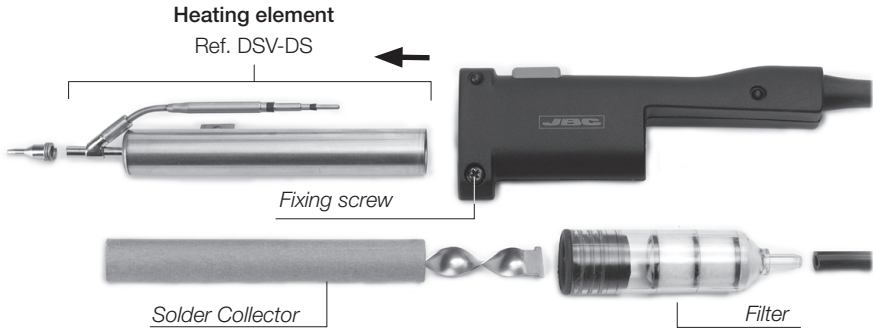

Changing the Pump Filters

Important:
Do not open the Suction filter with sharp pointed objects in order to avoid damage.

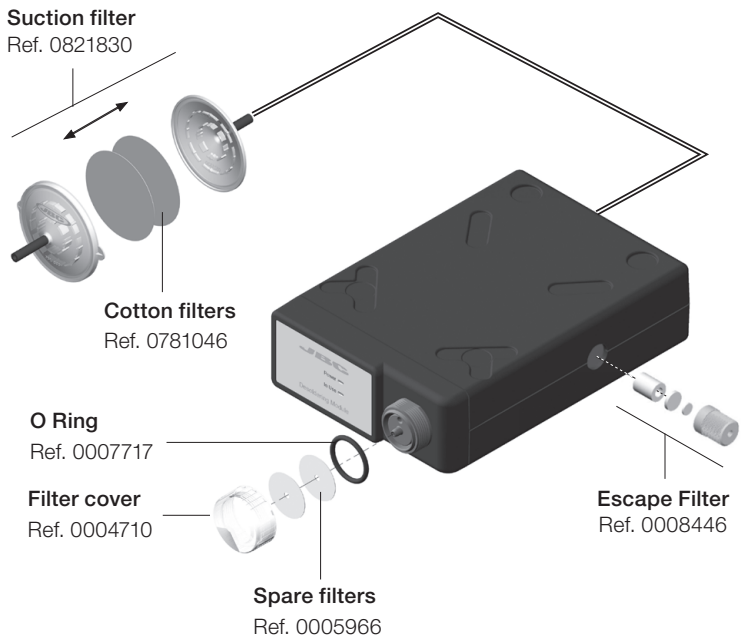

Maintenance

Before carrying out maintenance or storage, always allow the equipment to cool.

- Clean the station's screen with a glass cleaner or a damp cloth.
- Use a damp cloth to clean the casing and the tool. Alcohol can only be used when cleaning the metal parts.
- Periodically check that the metal parts of the tool/stand are clean so that the station can detect when the tool is in the stand.
- Maintain tip surface clean and tinned prior to storage in order to avoid tip oxidation. Rusty and dirty surfaces reduce heat transfer to the solder joint.
- Periodically check all cables, tubes and filters to ensure proper solder suction.
- Replace a blown fuse as follows:

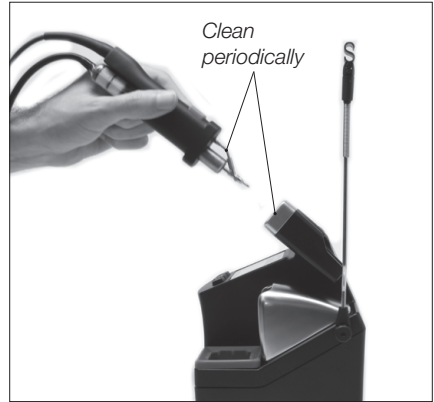

Remove the fuse by pulling the black cap. If necessary use a tool to lever it off.

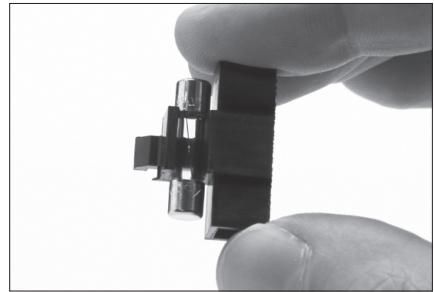

Press the new fuse into the holder and replace it in the station.

- Replace any defective or damaged pieces. Use original JBC spare parts only.
- Repairs should only be performed by a JBC authorized technical service.

Safety



It is imperative to follow safety guidelines to prevent electric shock, injury, fire or explosion.

- Do not use the units for any purpose other than soldering or rework. Incorrect use may cause fire.
- The power cord must be plugged into approved bases. Be sure that it is properly grounded before use. When unplugging it, hold the plug, not the wire.
- Do not work on electrically live parts. Antistatic handle of soldering irons is electrically conductive.
- The tool should be placed in the stand when not in use in order to activate the sleep mode. The soldering tip, the metal part of the tool and the stand may still be hot even when the station is turned off. Handle with care, including when adjusting the stand position.
- Do not leave the appliance unattended when it is on.
- Do not cover the ventilation grills. Heat can cause inflammable products to ignite even when out of sight.
- Use a "non residue" classified flux and avoid contact with skin or eyes to prevent irritation.
- Be careful with the fumes produced when soldering.
- Keep your workplace clean and tidy. Wear appropriate protective glasses and gloves when working to avoid personal harm.
- Utmost care must be taken with liquid tin waste which can cause burns.
- This appliance can be used by children over the age of eight and also persons with reduced physical, sensory or mental capabilities or lack of experience provided that they have been given adequate supervision or instruction concerning use of the appliance and understand the hazards involved. Children must not play with the appliance. Maintenance shall not be carried out by children unless supervised.

Exploded View

CV-1D 120V
 CV-2D 230V
 CV-9D 100V
 DESODERING STATION
 WITH PNEUMATIC PUMP

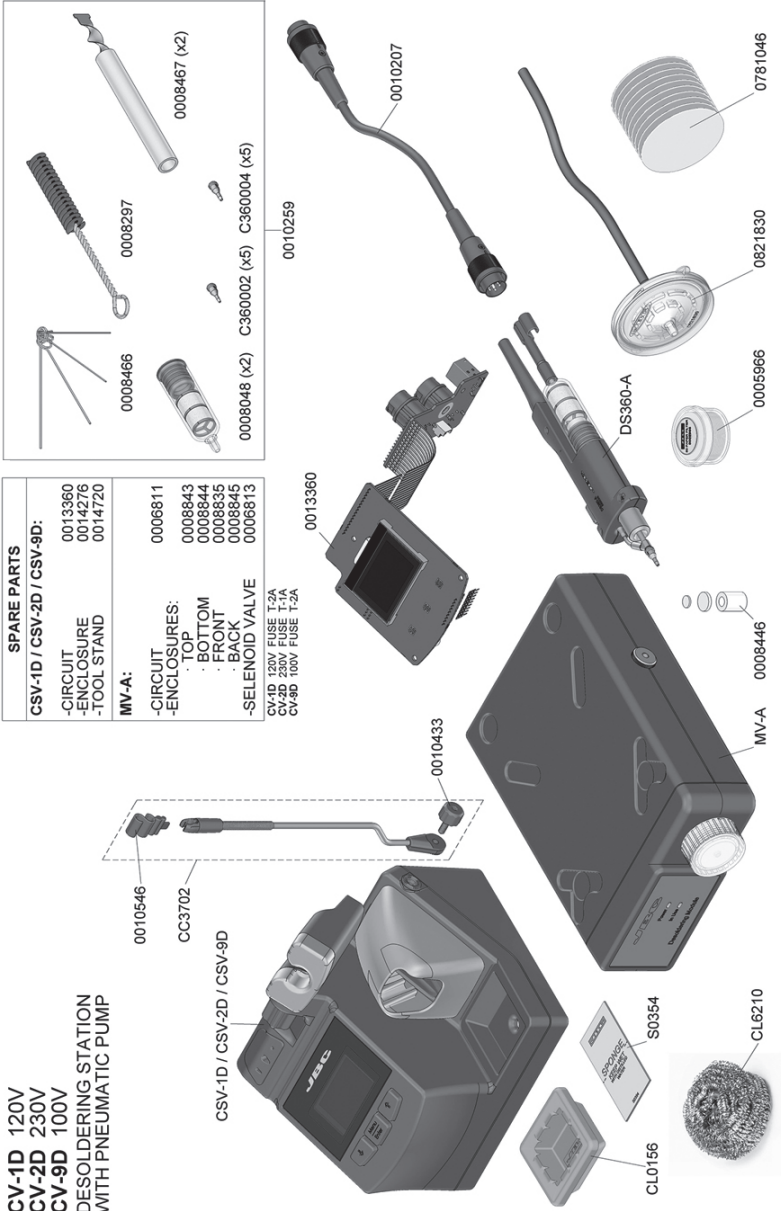

Specifications

CV-1D 120V 50/60Hz. Input fuse: 2A. Output: 23,5V.

CV-2D 230V 50/60Hz. Input fuse: 1A. Output: 23,5V.

CV-9D 100V 50/60Hz. Input fuse: 2A. Output: 23,5V.

- Total weight and size: 2,8 Kg (6.2lb) 150 x 175 x 145 mm
- Temperature selection: 180-450°C (356-842°F)
- Output Peak Power: 40W
- Tip to ground resistance: <2 ohms
- Safety transformer, mains separator and double isolation.
- Ambient operating temp: 10-40 °C / 50-104 °F
- USB connector station-PC

MV-A

- Total weight and size: 0.7 kg (1.6 lb) 145 x 55 x 225 mm
- Air pressure range supply: 4 - 6 bar
- Vacuum (at 6 bar): 90% / 680mmHg / 26.8 inHg
- Flow rate: 15 SLPm

Comply with CE standards.

ESD protected housing "skin effect".

JBC

Warranty

JBC's 2 year warranty covers this equipment against all manufacturing defects, including the replacement of defective parts and labour.

Warranty does not cover product wear due to use or mis-use.

In order for the warranty to be valid, equipment must be returned, postage paid, to the dealer where it was purchased.



This product should not be thrown in the garbage.
In accordance with the European directive 2002/96/EC, electronic equipment at the end of their life must be collected and returned to an authorized recycling facility.